



产品规格书

PRODUCT SPECIFICATION

客户名称Buyer Name	
客户料号Buyer Part No.	
客户承认签章 Buyers Approval & Signatures	

文件编号Spec No.		版本	A/0
品名描述 Product Description	圆柱直流马达 Cylindrical DC motor		
型号Part No.	VZ4KH1A0031122N		
送样日期Date			
设计Designed by	审核Checked by	批准Approved by	
陳满	陈满	陈满	
2022.03.02	2022.03.02	2022.03.02	

www.vybronic.com

sales@vybronic.com

规格书内容/Contents

1、适用范围/ General Scope	3/9
2、使用条件/ Operating Conditions	3/9
3、测定条件/ Measuring Conditions	3/9
4、机械要求/ Mechanical Specifications	3/9
5、性能特征/ Performance and characteristics	4/9
6、可靠性/ Reliability	5/9
7、要求/ Requirements	6/9
8、使用时注意事项/ Attentions	6/9
9、包装/ Packaging	7/9
10、外形图/ Outline Drawing	8/9
11、修改记录 / Revision History	9/9

1. 适用范围/ General Scope

本说明书适用于圆筒式永磁直流电机 VZ4KH1A0031122N 型

This specification applies to cylindrical permanent-magnetic motors DC model VZ4KH1A0031122N

2. 使用条件/ Operating Conditions

项目/Item	规格/Specifications	条件·备注/Conditions & Remarks
2-1 额定电压 Rated voltage	1.3V DC	
2-2 额定负荷 Rated load	振子 Counterweight	见 10. 外形图 As specified in 10. Outline Drawing
2-3 旋转方向 Rotation	C.W/C.C.W (clockwise or counter clockwise)	
2-4 马达位置 Motor position	全方位 All position	
2-5 使用电压范围 Operating voltage	1.1~1.6V DC	
2-6 使用环境 Operating environment	-30 ~ 70℃, 常湿 /Ordinary Humidity:65±20%RH	无水气凝结 No condensation of moisture
2-7 保存环境 Storage environment	-40 ~ 80℃, 常湿 /Ordinary Humidity:65±20%RH	无水气凝结 No condensation of moisture

3. 测定条件/ Measuring Conditions

项目/Item	规格/Specifications	条件·备注/ Conditions & Remarks
3-1 温度 Temperature	20±2℃	
3-2 湿度 Humidity	(63%~67%) RH	
3-3 位置 Motor position	轴向水平 Motor shaft horizontal	将马达固定在试验台上 Lock the motor in a test fixture

标准测试条件为温度 20℃, 湿度 65%。如无疑异, 也可在温度 5~35℃、湿度 45~85% 的条件下测试。马达测试时, 放置方向为轴向水平。/The measurement at 20℃ & 65%RH is standard. If the judgment is not questionable, recognize measurement at 5℃ to 35℃ & relative humidity 45% to 85%. Direction of motor is shaft horizontal.

4. 机械要求/ Mechanical Specifications

项目/Item	规格/Specifications	条件·备注/ Conditions & Remarks
4-1 结构 Configuration	见 10. 外形图 As specified in 10. Outline Drawing	Outline drawing No: VZ4KH1A0031122N
4-2 外观 Appearance	不含有机械损坏及不充分的浸蚀等。 There shall be no evidence of mechanical damage and shall not have inadequate corrosion and so on	目测 (容许范围根据样品外形) Visual examination(allowable extent is based on boundary sample)
4-3 轴向间隙 Shaft end play	0.05mm~0.2mm	
4-4 振子固定力 Holding strength of vibration weight	49N (5kgf) Min	

5.性能特征/Performance and characteristics

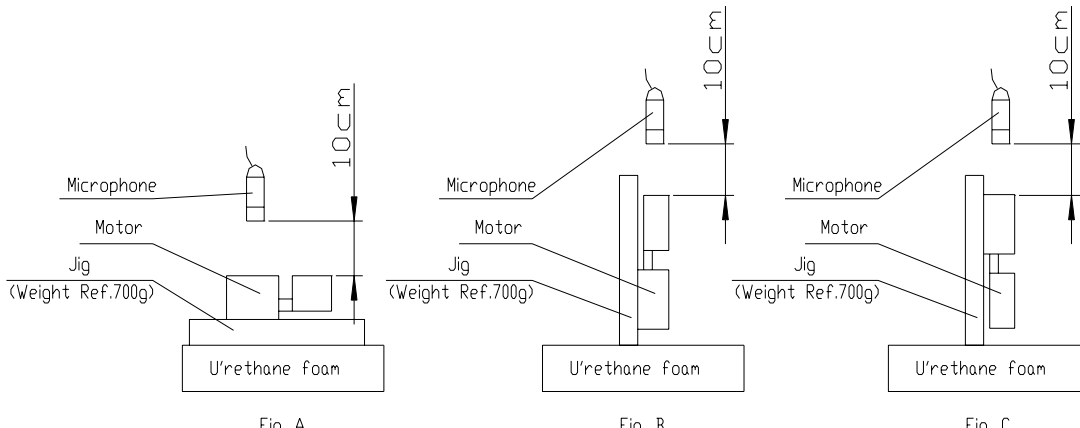
项目/Item		规格/ Specifications	条件·备注/ Conditions & Remarks
5-1	额定转速 Rated speed	8500±2000 rpm	在额定电压和额定负载（振子）下。 At rated voltage and rated load (Counterweight).
5-2	额定电流 Rated current	85 mA Max	
5-3	堵转电流 Stall current	125 mA Max	在额定电压下。 At rated voltage
5-4	起动电压 Starting voltage	1.0V DC Max	在额定负载（振子）下电枢的任意位置。 At rated load (Counterweight) any position of rotor.
5-5	绝缘电阻 Insulation resistance	1MΩ Min	在 100V 直流下，端子和机壳间 At DC 100V between Terminal and case.
5-6	端子阻抗 Terminal resistance	13Ω (±20%)	在 20℃ 下 At 20℃
5-7	机械噪音 Mechanical noise	50dB(A)Max	<p>在额定电压、额定负载（振子）下 背景噪音：不大于 28dB.A 计权 测试仪器：B&k 夹具重量：700g At rated voltage and rated load (Counterweight). Back ground noise 28dB(A) Max Measuring instruments: B&k Weight of jig:700g</p> 

6. 可靠性/Reliability

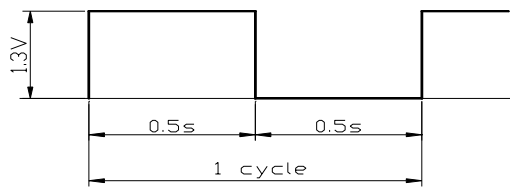
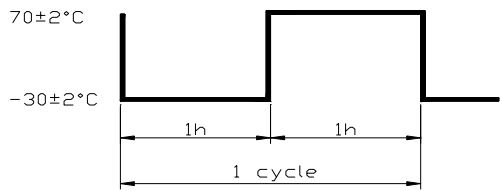
项目/Item	规格/ Specifications	判定标准/Judgment												
6-1 寿命 Life time		试验后, 马达应符合项 7-1 的要求。 After the test, motors shall be approved as specified in item 7-1.												
	<table border="1"> <tr> <td>位置 Position</td> <td>电压 Volt</td> <td>负荷 Load</td> <td>温度 Temp</td> <td>湿度 Humi</td> <td>寿命 Life</td> </tr> <tr> <td>轴水平 Horizon</td> <td>Rated 额定</td> <td>Weight 振子</td> <td>20°C</td> <td>65%</td> <td>200,000 Cycles</td> </tr> </table>		位置 Position	电压 Volt	负荷 Load	温度 Temp	湿度 Humi	寿命 Life	轴水平 Horizon	Rated 额定	Weight 振子	20°C	65%	200,000 Cycles
	位置 Position		电压 Volt	负荷 Load	温度 Temp	湿度 Humi	寿命 Life							
轴水平 Horizon	Rated 额定	Weight 振子	20°C	65%	200,000 Cycles									
<table border="1"> <tr> <td>位置 Position</td> <td>电压 Volt</td> <td>负荷 Load</td> <td>温度 Temp</td> <td>湿度 Humi</td> <td>寿命 Life</td> </tr> <tr> <td>轴水平 Horizon</td> <td>Rated 额定</td> <td>Weight 振子</td> <td>20°C</td> <td>65%</td> <td>200,000 Cycles</td> </tr> </table>	位置 Position	电压 Volt	负荷 Load	温度 Temp	湿度 Humi	寿命 Life	轴水平 Horizon	Rated 额定	Weight 振子	20°C	65%	200,000 Cycles		
位置 Position	电压 Volt	负荷 Load	温度 Temp	湿度 Humi	寿命 Life									
轴水平 Horizon	Rated 额定	Weight 振子	20°C	65%	200,000 Cycles									
6-2 低温放置 Low temp exposure	温度 /Temperature: $-40\pm 2^{\circ}\text{C}$ 时间 /Time: 96h	在常温常湿下放置 2h 后, 马达应符合项 7-2 的要求。 After 2 hours exposure in ordinary temperature and humidity, Motors shall be approved as specified in item 7-2.												
6-3 高温放置 High temp. Exposure	温度 /Temperature: $80\pm 2^{\circ}\text{C}$ 时间 /Time: 96h													
6-4 湿度放置 Humidity exposure	温度 /Temperature: $40\pm 2^{\circ}\text{C}$ 湿度 /Humidity: 90~95%RH 放置时间 /Exposure time: 96h 无水气凝结/No condensation of moisture													
6-5 振动 Vibration	频率 /Frequency: 10~55~10Hz 全振幅 /Displacement: 1.5mm (p-p) 加速度 /Acceleration: 22m/s^2 周期 /Period: 20min 完成 10~55~10Hz /20 Minutes log sweep 10~55~10Hz 方向 /Direction: x, y, z 时间 /Time: 每个方向 2h /Each 2 hours	测试结果应符合项 7-2 的要求。 After the test motors shall be approved as specified in item 7-2.												
6-6 自然跌落 Free fall	试验状态/Test state: 将马达固定在约 100 克 (包括马达本身) 的物体上, 落向水泥地面。 Set the motor to the approximately 100g (include the motor) weight of block drop the motor on the concrete floor. 高度 /Height: 1.5m 方向 /Direction: 6 个面 / 6 faces 次数 /Number of times: 每个面 2 次 / Twice 2 each	测试结果应符合项 7-2 的要求。 After the test motors shall be approved as specified in item 7-2.												
6-7 热冲击 Heat shock test	试验循环 /Test cycle :20 cycles 	在常温常湿下放置 2h 后, 马达应符合项 7-2 的要求。 After 2 hours exposure in ordinary temperature and humidity, Motors shall be approved as specified in item 7-2.												

7. 要求/Requirements

项目/Item		判定基准 / Requirements	
7-1	表 A Table A	1) 额定转速/Rated speed:	不低于初始值-30%,不高于初始值+60% Initial data -30% Min, Initial data +60% Max
		2) 额定电流/Rated current:	不大于初始值±30%/Initial data±30% max
		3) 起动电压/Starting voltage:	1.1V DC Max
7-2	表 B Table B	1) 额定转速/Rated speed:	不大于初始值±30%/Initial data±30% max
		2) 额定电流/Rated current:	不大于初始值±30%/Initial data±30% max
		3) 起动电压/Starting voltage:	1.1V DC Max

8. 使用时注意事项/Matters to be paid attention to when using motor

8-1 电机在运输过程中应小心轻放，避免严重碰撞敲击引起的电机机身和性能受损。(Please lay the motors carefully in transportation to avoid any serious damage to the motor body or its electric function because of collision.)

8-2 请按照规格书中规定的第 2 条(使用条件)来使用和存储电机，否则会影响电机性能。(Please use and storage motors according to N0.2 item (Operating Conditions) in specification, or else motor characteristics would be affected.)

8-3 请在 6 个月内使用。在使用和打开马达外包装时请避免水气凝结。(Make arrangement to limit the storage period to 6 months or less. Condensation of atmosphere must be avoided in motor usage or opening the packaging of the motor.)

8-4 马达应适当的操作、储存和运转环境中均不可存在腐蚀性气体。例如：H₂S、SO₂、NO₂、CL₂ 等。另外存储环境中不可有诸如硅、氰、甲醛水和苯酚等能放射出腐蚀性气体的物质，在电机的机械构造或装置中，如果存在腐蚀性气体，那么这会引起马达不运转。(For proper operation. storage and operating environment must not contain corrosive gases. For example H₂S. SO₂. NO₂. CL₂. etc. In addition storage environment must not have materials that emit corrosive gases especially from silicon. cyanic. formalin and phenol group. In the mechanism or the set. existence of corrosive gases may cause no rotation in motor.)

8-5 请通电后不要长时间堵住机轴，并且马达转动时不要触碰转子。(Please don't stall the shaft for a long time after powering, and not to touch the weight when motor is rotating.)

8-6 马达轴向间隙处不应有杂物（如颗粒、纤维物、头发、胶带、胶水等）(There should be no sundries (such as grain, fibre, hair, small tape, glue etc.) in the shaft end play.)

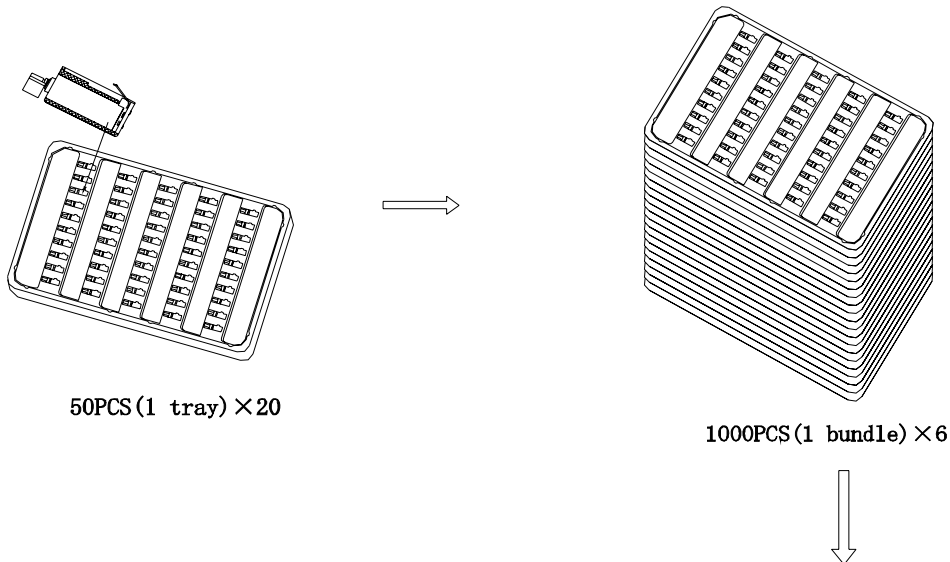
9. 包装/Packaging
**圆柱马达包装
Packaging drawing of cylindrical motor**

包装试验要求
1. 标准

- (1) 整箱重量小于等于9kg的, 跌落高度设定为75cm.
- (2) 整箱重量大于9kg但小于等于23kg的, 跌落高度设定为60cm.

2. 试验方法:

跌落要求为六面三棱一角.

- (1) 六面: 先从最大两面跌, 然后是中间大小的两面, 最后跌最小的两面, 一共六次.
- (2) 三棱: 指任选三条同一角的棱, 跌落秩序: 最长棱, 中间长度, 最短的, 一共三次.
- (3) 一角: 指上一步三条棱所组成的角, 跌落一次.

3. 判定基准

经过跌落试验后, 产品外观、性能无不良。

Package Test Requirement:
1. Criteria

- (1) The weight of the whole carton less than 9kg, the dropping height is 75cm.
- (2) The weight of the whole carton more than 9kg and less than 23kg, the dropping height is 60cm.

2. Test Methods:

Dropping requirement is 6 faces, 3 aris, 1 angle.

- (1) 6 faces: First dropping with two biggest faces, then dropping with another two middle faces, at last dropping with two smallest faces, once per face, total 6 faces.
- (2) 3 aris: Choose any 3 aris which make up of the same the angle, the dropping sequence is the longest aris, middle aris, shortest aris. Total 3 times.
- (3) 1 angle: Point to the angle which is made up with the 3 aris in the above step. Dropping for 1 time.

3. Judgement Criterion

After drop test, no evidence of damage on the appearance and performance.

Remarks:

- 1000PCS/CTN: 24cm × 17.5cm × 27.5cm
 2000PCS/CTN: 34cm × 24cm × 27.5cm
 4000PCS/CTN: 47cm × 34cm × 27.5cm
 6000PCS/CTN: 51cm × 47cm × 27.5cm

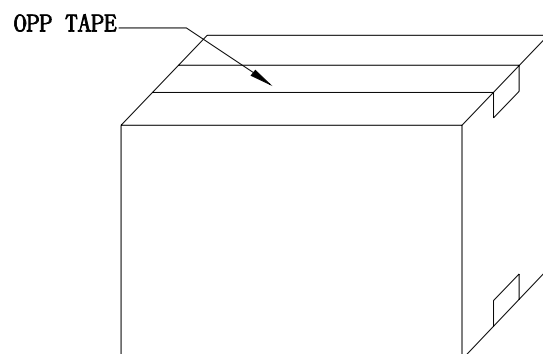

10. 外形图/Outline Draw

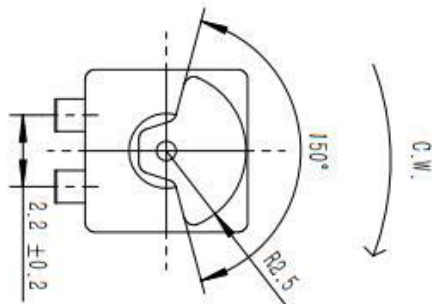
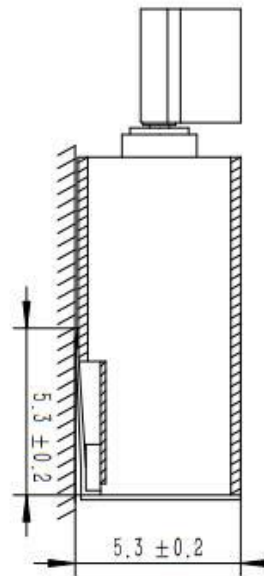
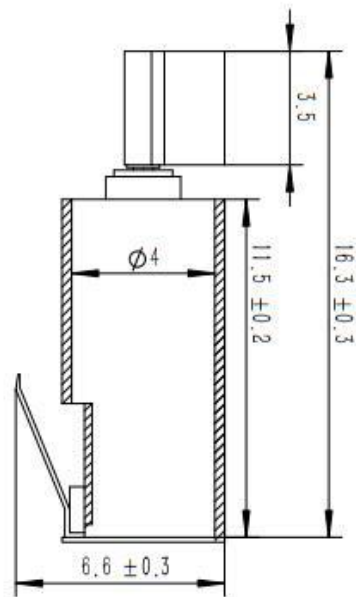
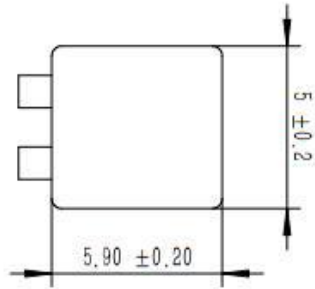

未注公差 Unmarked tolerance: ±0.1.

11.更改记录/ Revision history

修改号 Rev.No.	日期 Rev. Date	页码 Page No.	修改项目 Revised Item	更改原因 Reason
A/0	2021.03.10	/	初始规格/Preliminary spec	