



产品规格书

PRODUCT SPECIFICATION

客户名称Buyer Name	
客户料号Buyer Part No.	
客户承认签章 Buyers Approval & Signatures	

文件编号Spec No.		版本	A/1
品名描述 Product Description	圆柱直流马达 Cylindrical DC motor		
型号Part No.	VZ30F4B8196812L		
送样日期Date			
设计Designed by	审核Checked by	批准Approved by	
2020.07.01	2020.07.01	2020.07.01	

www.vybronic.com

slaes@vybronic.com

- 目录/List -

1. 封面	1/17
2. 目录	2/17
3. 更改记录/Records of Revision	3/17
4. 结构形式/Construction Form	4/17
5. 适用范围/Scope Of Application	4/17
6. 测试条件/Testing Condition	5/17
7. 贮存环境/Storage Environment	5/17
8. 电气特性/Electrical Characteristics	5/17~6/17
9. 机械特性/Mechanical Characteristics	7/17~8/17
10. 可靠性试验/Reliability Test	9/17~12/17
11. 环保要求/Environment Protections	12/17
12. 注意事项/Caution	12/17~14/17
13. 外形图/Outside View	15/17
14. FPC图纸/FPC Drawing	16/17
15. 包装要求/Packaging require	17/17

3. 更改记录/ Records of Revision

修改号 Rev. No.	日期 Rev. Date	页码 Page No.	修改项目 Revised Item	更改原因 Reason
A/0	2018.07.29	/	产品颁布/ Release for Production	
A/1	2020.07.01	/	changed company name from JINLONG MACHINERY to VYBRONICS, changed part # from Z30F4B8196812L to VZ30F4B8196812L	Rebranding

4. 结构形式/Construction Form

This specification sheet is stipulated for vibration motor, which is for mobile phone.

NO.	项目/Item	规格/Specifications
4-1	电机结构 Motor construction	Φ3.2 圆柱形铁芯直流电机 Φ3.2 DC Cored motor
4-2	换向片数 Number of phases	3 组换向片 3-phases
4-3	磁极数 Number of magnet poles	两极 (外置磁极型式) 2-poles (Inner magnet type)
4-4	线圈 Coil construction	铁芯线圈 Iron-cored coil
4-5	整流技术 Rectifying method	采用高精度电刷和换向器 Precious brush and commutator

5. 使用条件/Standard operating condition

NO.	项目/Item	规格/Specifications
5-1	额定电压 Rated voltage	DC2.7V
5-2	使用电压范围 Operating voltage range	DC 2.3~3.5V
5-3	旋转方向 Rotating direction	CW / CCW
5-4	使用温度范围 Operating temperature range	-30℃~+70℃

6. 测试条件/Testing condition

NO.	项目/Item	规格/Specifications
6-1	温度 Temperature	20°C ±2
6-2	湿度 Humidity	45% ~85%RH
6-3	电源电压 Power supply, voltage source	直流电源或电池. 2. 7V DC power supply or battery 2. 7V
6-4	马达安放状态 Posture of motor	水平

7. 贮存环境/Storage environment

NO.	项目/Item	规格/Specifications
7-1	贮存温度 Storage temp	-40°C ~+85°C
7-2	相对湿度 relative humidity	5%~95% (No condensation of moisture/无水 汽凝结)

8. 电气特性/Electrical characteristic

NO.	项目/Item	单位 /Unit	规格/SPEC.	条件/Condition
8-1	额定转速 Rated speed	rpm	14000 ±2500	额定电压:DC 2. 7V Rated voltage:DC 2. 7V
8-2	额定电流 Rated current	mA	75Max	在额定电压和额定负载下测试 /Measure at rated voltage and rated load
8-3	启动电流 Starting current	mA	90Max	在额定电压下锁定振动轮, 测电机 电流 (2/3R 极端电阻处, 不在电刷 和整流子两点接触的位置)/Measure current at locked counter weight (R1.7×2.8) in rated voltage(2/3R R:1 extreme resisting rate,Not in the position when the brushes contact the commutator at the two contact points)

8-4	启动电压 Starting voltage	V	2.3Max	DC2.3V电压下，开/关为1个循环，共3个循环 On/off-1cycle, total 3cycles under DC2.3V
8-5	端子阻抗 Terminal resistance	Ω	单相 1phase: 33 ± 6	正极和负极之间 Between positive and negative
8-6	绝缘电阻 Insulation resistance	M Ω	10Min	测量机壳和引线之间。 测试电压直流100V。 Measuring between case and lead wire. Test voltage DC 100V

9. 机械特性/Mechanical characteristics

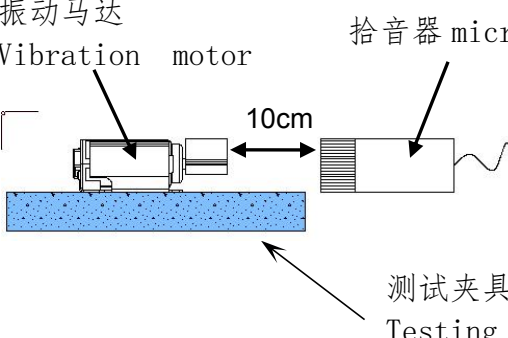
NO	项目/Item	单位/Unit	规格/SPEC.	条件/Condition
9-1	外观 Appearance	/		目测/Visual
9-2	尺寸 size	mm	见外形图/See outline of drawing	使用游标卡尺和千分尺测量/Use vernier caliper and micrometer to measure
9-3	马达重量 Motor Weight	g	0.7±0.2g	使用天平测量/Use scale
9-4	机械噪音 Mechanical Noise	dB	50 MAX	<div style="display: flex; justify-content: space-around; align-items: flex-start;"> <div style="text-align: center;"> <p>振动马达 Vibration motor</p>  </div> <div style="text-align: center;"> <p>拾音器 microphone</p> </div> </div> <p>测试夹具 (75g) Testing Jig (75g)</p> <p>马达: 被固定/Motor : be fixed 额定电压:DC 2.7V/Rated voltage : DC 2.7V 背景噪音: 25dB MAX. Back ground noise: 25dB MAX. 拾音器沿轴向正对电机平面 Microphone faces the plane of motor along the shaft</p>

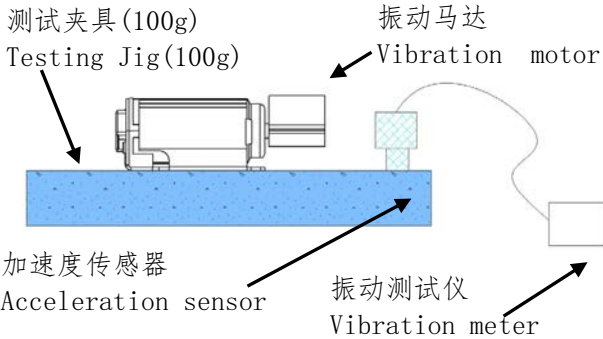
9-5	振动量 Vibration Strength	Gms	0.41 MIN	 <p>测试夹具(100g) Testing Jig(100g)</p> <p>振动马达 Vibration motor</p> <p>加速度传感器 Acceleration sensor</p> <p>振动测试仪 Vibration meter</p> <p>马达: 被固定/Motor : be fixed. 额定电压:DC 2.7V/Rated voltage : DC 2.7V .</p>
		Gp	0.55 MIN	

Jig(90*50*8 Aluminum plate)
Total weight 100g include
vibrator and senser.

10mm minimum
thickness sponge

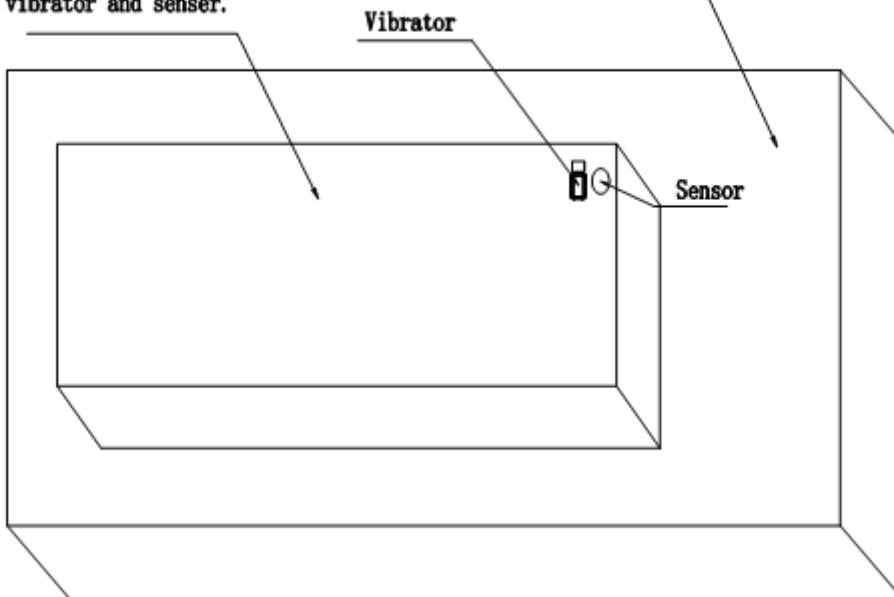

Simulation Vibration test method

10. 环境试验/Environmental test

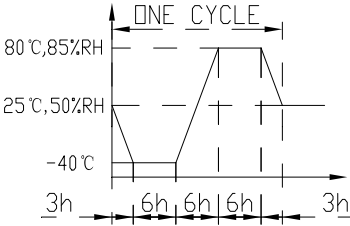
NO	项目/Item	条件/Condition
10-1	高温贮存试验 High temperature Storage test	在+80℃的环境下放置96小时，然后在常温常湿下恢复4小时后测试。 Exposed at +80℃ for 96hours, then return to normal temperature and humidity for 4 hours before test.
10-2	低温贮存试验 Low temperature Storage test	在-40℃的环境下放置96小时，然后在常温常湿下恢复4小时后测试。 Exposed at -40℃ for 96hours, then return to normal temperature and humidity for 4 hours before test.
10-3	湿热试验 Humidity test	在温度50℃，湿度95%的环境下放置96小时，然后在常态下放置4小时后测试。/Resistan cetest 96hrs at 50℃,96%HR,then recovery 4hr at normal temperature.
10-4	高低温试验 Heat cycle test	确保电机在下图所示的条件下放置一个周期(马达表面避免有水汽凝结)，然后在室温下恢复4小时后，进行测试。/Confirmed to operating of motor during 1 cycles as following test condition (without presence of water droplets on the motor), then return to normal temperature and humidity for 6 cycle before test. <div style="text-align: center;">  </div>
10-5	振动试验 Vibration test	将马达固定在100g的塑料夹具上，按以下要求进行试验： 1) 振频范围:10-55Hz 2) 全振幅 2mm 3) 振频变化10-55-10 约1分钟 4) 振动方向: 三个垂直方向 5) 持续时间: 每个方向30分钟 (共90分钟) The motor that is attached to a 100g jig (plastic housing) and test according following condition: 1)Vibration frequency range: 10~55Hz 2)Total amplitude: 2 mm 3)Sweep ratio: 10~55~10Hz approximate 1min 4)Direction of vibration: Three perpendicular directions 5)Duration: 30min(90min in total)

10-6	跌落试验 Drop test	将马达电机放在大约60g（包括电机）重的物体上，从1.5米的高度跌落到20mm厚的大理石板上，跌落18次。/Drop the motor from the height of 1.5 meters to the marble board of 20mm thick, Drop 18 times. 高度/Height: 1.5m 方向/Direction: $\pm X$, $\pm Y$, $\pm Z$ 次数/Times: 每一平面下落3次，共计18次/Three drops per plane for a total of 18 drops.
------	-------------------	--

► 判定标准/Judgment standard

① 试验后，测试数据必须符合以下规格：

After test, measured data must be satisfied as following specifications;

- 启动电压: DC2.3V MAX.
- Starting voltage: DC2.3V MAX.
- 额定转速: 变化率在初始值的+30%~-20%以内。
- Rated speed: changing rate must be within +30%~-20% of initial value.
- 额定电流: 变化率在初始值的+20%~-30%以内。
- Rated current: changing rate must be within +20%~-30% of initial value.
- 端子阻抗: 变化率在初始值的 $\pm 15\%$ 以内。
- Terminal resistance: changing rate must be within $\pm 15\%$ of initial value.

② 外形结构无异常.

There should be no abnormalities in appearance and structure.

10.1. 寿命试验/Life test

输入 2.7V 电压/Input voltage 2.7V.

带负载重量 (R1.7, t2.8 大约 0.30g) /Load counter weight (R1.7, t2.8 appx0.30g).

NO	项目/Item	条件/Condition
10.1 -1	常温寿命试验/Room Temperature Life Test	放置在室温25°C, 50%RH的湿度条件下/Room Temperature exposure 25°C, 50%RH .
10.1 -2	高温高湿寿命试验 /High temperature and Humidity Exposure Life test	放置在高温55°C, 95%RH的条件下/High Temperature exposure 55°C, 95%RH .
10.1 -3	低温寿命试验 /Low temperature Exposure Life test	放置在高温-20°C的条件下/Low Temperature exposure -20°C.

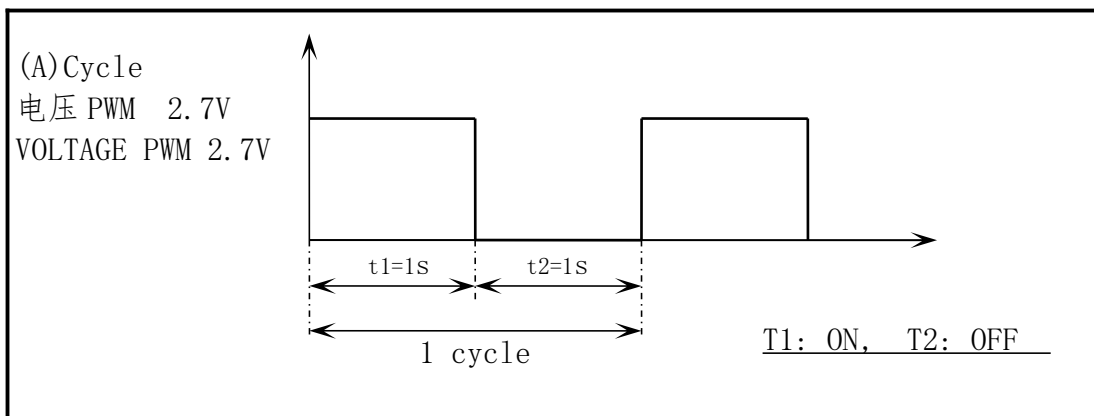
10.1-1-1 常温寿命试验/Room Temperature Life Test

1. 按A周期运行96小时/To maintain (A) cycle for 96hrs in the process of temperature shock.

10.1-2-1 高温寿命试验/High temperature Exposure Life test

1. 按A周期运行72小时/To maintain(A) cycle under high temperature for 72hrs.

10.1-3-1 低温寿命试验/Low temperature Exposure Life test

1. 按A周期运行72小时/To maintain(A) cycle under high temperature for 72hrs.

▶ 判定标准/Judgment standard

② 试验后，测试数据必须符合以下规格：

After test, measured data must be satisfied as following specifications;

- 启动电压: DC2.3V MAX.
- Starting voltage: DC2.3V MAX.
- 额定转速: 变化率在初始值的+30%~-20%以内。
- Rated speed: changing rate must be within +30%~-20% of initial value.
- 额定电流: 变化率在初始值的+20%~-30%以内。
- Rated current: changing rate must be within +20%~-30% of initial value.

11. 环保要求/Environment Protections

本产品所有零部件符合欧盟RoHS2.0/无卤/REACH指令要求，具体环境有害物质管控限制如下：

This product conforms to the EU ROHS2.0, halogen-free and REACH certification, Specific content as follows:

- 铅及其化合物最大允许含量为1000ppm/Lead and Lead compounds \leq 1000ppm
 - 镉及其化合物最大允许含量为1000ppm/Cadmium and cadmium compounds \leq 1000ppm
 - 汞及其化合物最大允许含量为1000ppm/Mercury and Mercury compounds \leq 1000ppm
 - 六价铬化物最大允许含量为1000ppm/Hexavalent chromium compounds \leq 1000ppm
 - 多溴联苯(PBB)最大允许含量为1000ppm/Polybrominated biphenylethers \leq 1000ppm
 - 多溴联苯醚(PBDE)最大允许含量为1000ppm/Polybrominated diphenylethers \leq 1000ppm
 - 邻苯二甲酸二正丁酯(DBP)最大允许含量为1000ppm /DBP \leq 1000ppm
 - 邻苯二甲酸正丁基苄酯(BBP)最大允许含量为1000ppm/BBP \leq 1000ppm
 - 邻苯二甲酸(2-己基)己酯(DEHP)最大允许含量为1000ppm/DEHP \leq 1000ppm
 - 六溴环十二烷(HBCDD)最大允许含量为1000ppm/HBCDD \leq 1000ppm
 - 溴Br最大允许含量为900ppm/Br \leq 900ppm
 - 氯Cl最大允许含量为900ppm/Cl \leq 900ppm
 - 溴加氯之和最大允许含量为1500ppm/Br+Cl \leq 1500ppm
- REACH指令按最新法规内容管控执行
- 包装材料环保管控要求：Pb, Cd, Hg, Cr+6 : 4种物质总和 $<$ 100ppm (其中, Cd $<$ 50ppm)。

12. 注意事项/CAUTION FOR USE

(1) 该马达是微型精密产品，在运输过程中不要承受超过0.5 kgf的力，否则会引起外形或性能的变化。

As this motor is small and precise, do not press it over 0.5kgf force or while transportation, it can cause the transformation of performance or external appearance.

- (2) 请注意马达不要接触到液体性物质（比如：水，酒精等）
please be careful, not to be contacted fluid substances
(such as: water, alcohol etc.)
- (3) 不要在高温下长时间放置，否则有可能导致电机的性能下降。
Do not expose the motor to high temperature for a long periods of time,
it may cause a decline in performance.
- (4) 马达不要在以下环境中使用：
- 高温和高湿的场所
- 腐蚀性气体如H₂S、SO₂、NO₂等
Avoid using the motor in the following environment.
- High temperature and high humidity area.
- Corrosive gas such as H₂S、SO₂、NO₂ etc.
- (5) 请不要在靠近磁铁或带有磁场的仪器旁边使用或存放马达。
Please do not operate or store the motor adjacent to magnet or apparatus
That has a magnetic field.
- (6) 请注意机壳的表面存在漏磁通量。
Please be careful that there exists a leaking magnetic flux on
the surface of bracket.
- (7) 电刷和换向器的相互作用，有可能产生轻微的电噪音。
Due to interaction between brush and commutator, there is a possibility to
occur electrical noise slightly.
- (8) 因测试设备有误差，允许有±5%偏差。
Beacuse there is error of the measurement equipment ,permit the standard
of the rotational frepuency to ±5%
- (9) 接电端子扭曲、折弯次数不可多于2次。
Current terminals should not be twisted or bent more than twice.

(11) 被焊锡的端子局部受压不可多于2次/The portion when lead wire and terminal are soldered should not be under stressed more than twice.

(12) 在马达通电时, 不宜长时间锁住不转/Do not subject the motor under locked condition for long hours.

(13) 不可向马达一侧强行挤压接电端子/Do not exert pressure by pushing the current terminals towards the direction of the internal motor.

(14) 马达通过ROHS认证

This motor pass the system of ROHS certification.

(15)

出厂检验报告附上 35 只马达特性数据和 CPK 值,其中包括:

负载转速: rpm

负载电流: mA

堵转电流 (启动电流): mA

启动电压: 不考虑 CPK 值

Out-going test data and Cpk data will be attached (n-35) for
Loaded rotation r.p.m.

Loaded current mA

Lock current (Starting current) mA

Starting voltage V (without the consideration of Cpk value) .

13. 外形图/Outside view

Technical requirements:

1. The thickness of the pad is 0.025mm.
2. The plating of the pad:
 - Bottom: Ni 3~6 um
 - Surface: Au 0.1 um Min

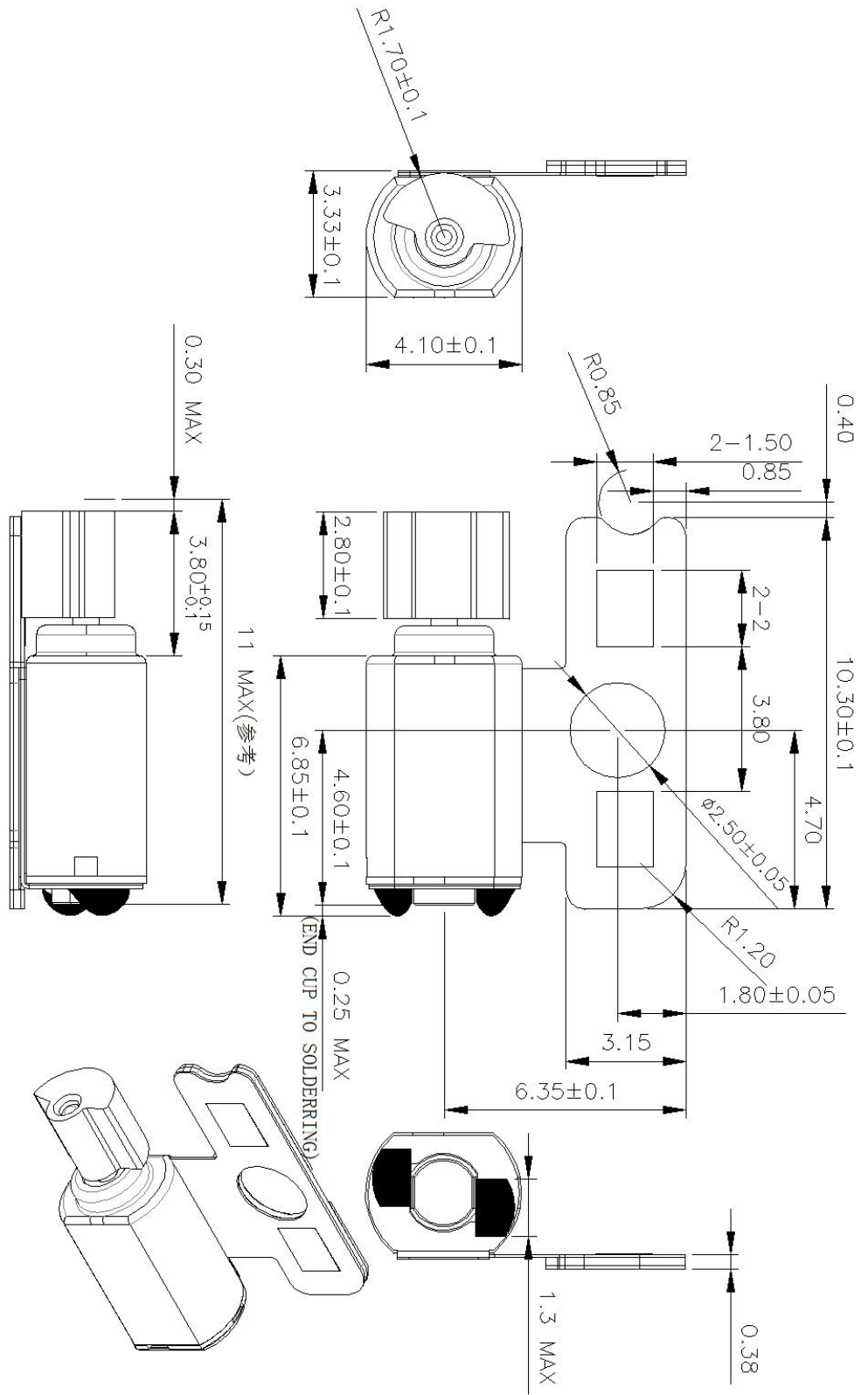

14. FPC 图纸/FPC Drawing

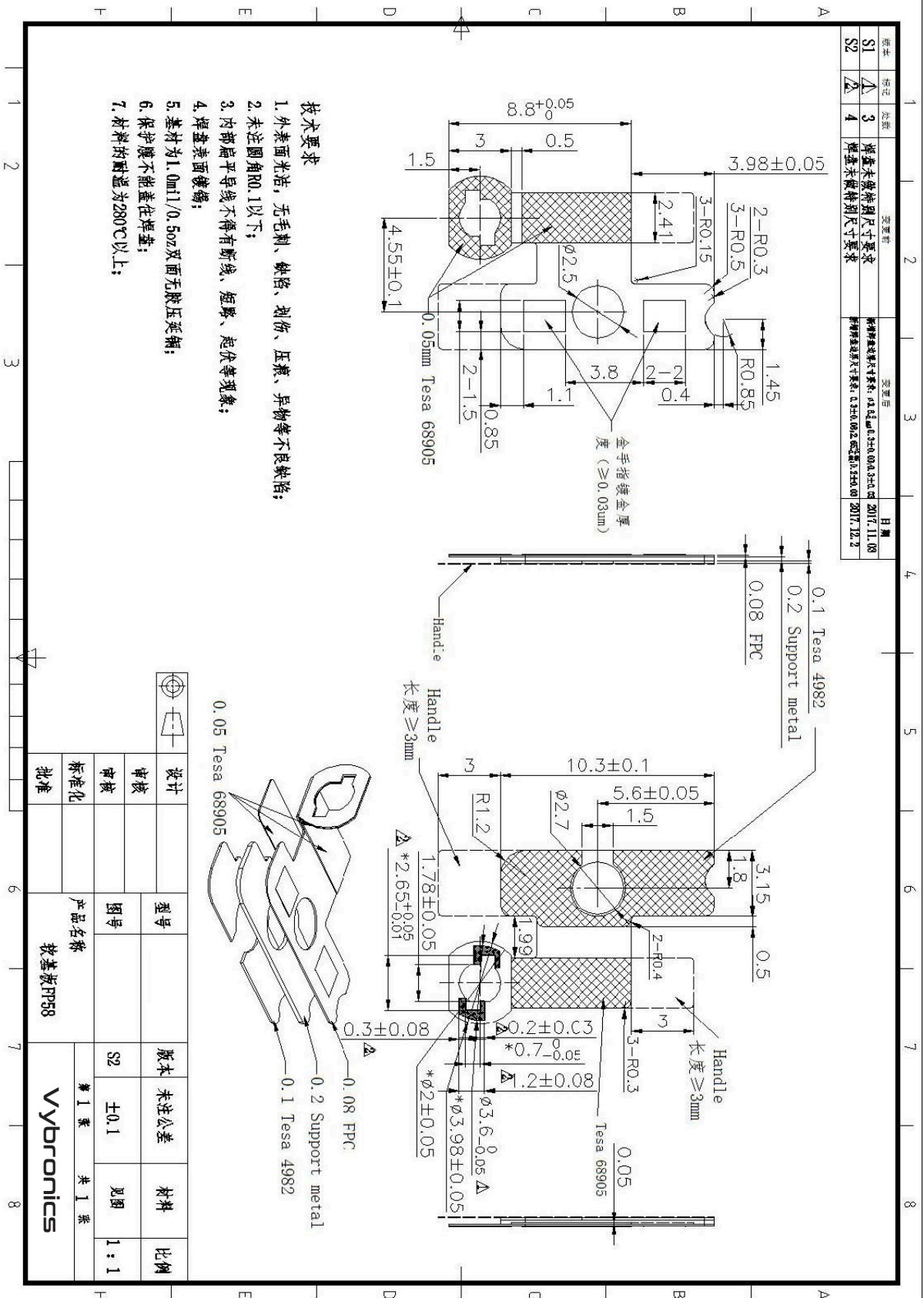

图号	图名	变更号	日期
S1	焊盘未做特制尺寸要求		2017.11.08
S2	焊盘未做特制尺寸要求		2017.12.2

设计	审核	型号	版本	材料	比例
审核	审核	图号	S2	未注公差 ±0.1	见脚 1:1
标准化	批准	产品名称	第 1 页	共 1 页	
		板基板FP58	Vytronics		

15. 包装要求/Packaging require

工作内容和程序/Content and process

1、50 vibrators in each plastic capsule./每个吸塑盒里放 50 个电机。

2、Every 25 capsules as a group put a plastic cover on the group and wrap it in tape./每 25 个吸塑盒上盖一个纸板盖，用胶带捆做一捆。

3、Every 4 bags are put into an outer case with a size of $350 \times 350 \times 260$ by the ways stipulated as the drawing./每 4 捆按图中的叠放方式放入一个外包箱（ $350 \times 350 \times 260$ ）。

4、Quantity and batch number are written on the surface of the outer case./数量、生产批号均写在外包装箱上。

